

Accelerometer + Magnetometer sensor  
LSM303AGR

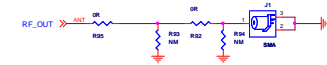

Relative humidity and temperature sensor  
HTS221

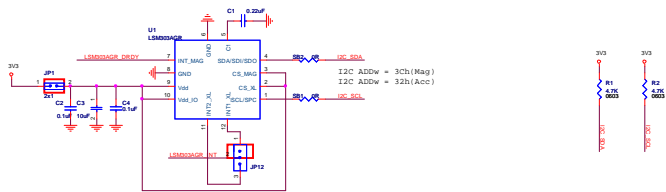
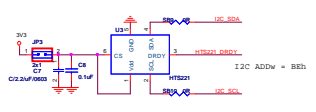

Pressure sensor  
LPS22HB

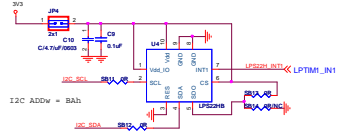

Arduino UNO R3 Connectors

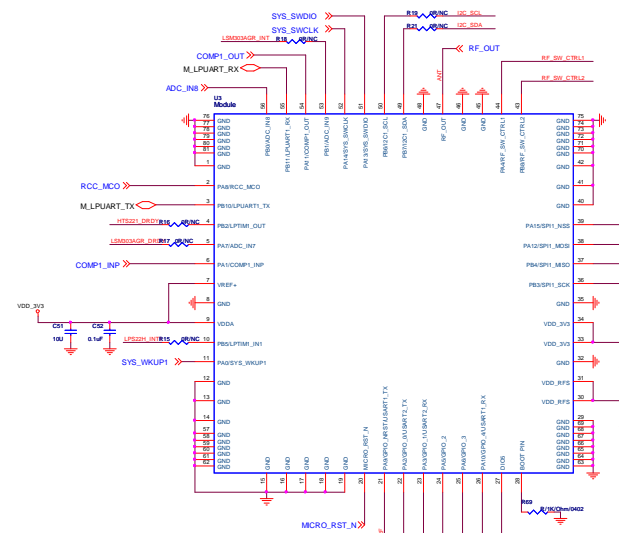
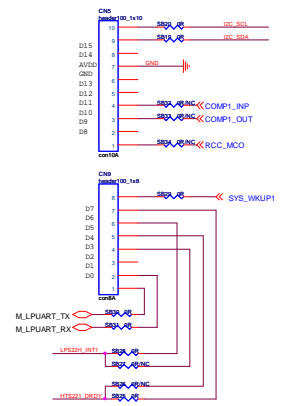
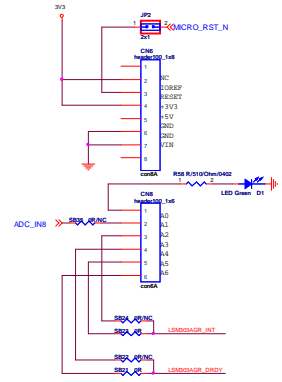

I2C grove connector

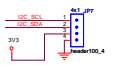

SWD

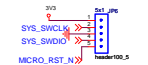

Reset Button

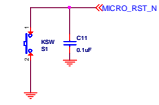

RF switch debug header



Debug connect

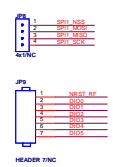

RF & MCU Power Consumption Measurement

